

100
ATLAS 1919 - 2019

ATLAS
SINCE 1919

**STABLE.
STRONG.
STEADY.**

-  17.0 - 19.6 t
-  105 kW (143 HP)
EU Stage V
-  0.7 - 1.1 m³



WHEELED EXCAVATOR 165W_{SR} blue

WWW.ATLASGMBH.COM

ATLAS – CONSTRUCTION MACHINERY MANUFACTURER WITH TRADITION

From person to person

When Hinrich Weyhausen started selling construction and agricultural machinery in 1919, he discovered that the machines which his customers actually needed were not available. So he listened to them carefully and went about building the machines himself – exactly according to the requirements of the people who used his machines every day. He carried out pioneering work with a passion under the brand name of Atlas. His focus was always on the benefit of the machines. And nothing has changed for us in terms of this ideal today.

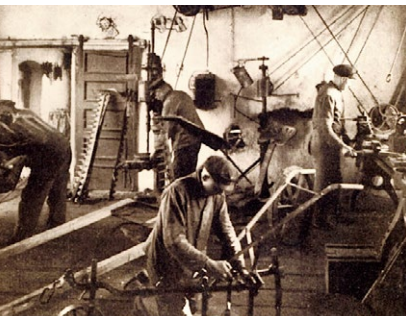

**Atlas will make you strong
with excellent products and
a comprehensive service.**



With highly motivated employees, a great deal of commitment and expertise ATLAS GmbH develops successful crane & excavator technologies. Numerous customers, engineers and experts all around the globe have made their contribution. The result is robust equipment to enable you to work more effectively and safely than ever before.

As our know-how grew, so too did our dealer and service network worldwide.

We can hence guarantee – in those days and today too – that we will always be on the spot when you need us.



Atlas manufactures a wide range of equipment for the construction, railroad, material handling and infrastructure industries. You will find more information on Atlas under www.atlasgmbh.com.

CONSTRUCTION



TRANSPORT



INFRASTRUCTURE



RECYCLING



CUSTOMER SATISFACTION IS OUR PRIORITY!

WE ARE COMMITTED

to providing our customers with highest quality products and services.

QUALITY STANDARDS AND CUSTOMER SATISFACTION

are measured in terms of service performance, reliability, relevance and timeliness.

OUR COMPANY'S MISSION, GOALS AND OBJECTIVES

are directed towards ongoing process improvement as a basis for strengthening our competitive position and for improving product quality and service standards.

QUALITY STANDARDS AND CUSTOMER SATISFACTION

are measured in terms of product performance and reliability.

PRODUCT RANGE

165Wsr *blue*





**EXTENSIVE DEALER NETWORK
EXCELLENT SERVICE
CUSTOMER FOCUSED**

ATLAS - The new excavator cabin



The new ATLAS cabin – Best climate, sharp display, digital and direct, more space, best view, extremely quiet, feel good

Clear control panel – Direct selection via keys or digital control via button.....



Move safely: Standard lateral- and rear view cameras



Most powerful air conditioning system - short airways - large lines - cross sections - silent



Best view – especially to the right



ATLAS SINCE 1939 - The new excavator cabin

Stay communicated - radio with USB connection - mobile phone tray by the left joystick



Lunch break - space for cool box with electrical connection - behind the driver's seat



Easy: Upper carriage lock at the push of a button on T



If thirsty: Close at hand and quickly released



Floor non-slip and Easy to sweep - storage space for tools and materials



TECHNICAL SPECIFICATION 165Wsr

ENGINE

| | | |
|--|--|---|
| Power rating.....105 kW (143 HP) | Bore / cylinder stroke 101 / 126 | STANDARD BASIC EQUIPMENT: |
| RPM 1800/min | Cooling system Water-cooled | • Automatic idling system / Engine stop |
| Model..... Deutz TCD 4.1 L4 EU Stage V | Air filter..... Dry air filter | • Cold start assistance |
| Design..... Turbocharger | Battery..... 2 x 12 V / 100 Ah | • Diesel pre-filter |
| Cylinder capacity 4038 cm ³ | Generator 24 V / 100 A | • Engine monitoring |
| Number of cylinders 4 | Starter..... 24 V / 4 kW | |

HYDRAULIC SYSTEM

| | | |
|---|--|--|
| • AWE 5 system (Load sensing) | • Pipe break protection valves for lifting and articulated cylinders | • Operating modes: |
| • Load limit controlled high-performance pump | • Proportional grab and grab rotating function | F1 (Fine) |
| • Fuel-efficient flow-on-demand control | • 3 circuits for additional consumer loads possible | F2 (Eco) |
| • Sensitive, proportional, independent control | • Max. oil flow 240 l/min | F3 (Power) |
| • Primary and secondary protection against overload | • Max. operating pressure 350 bar | • Accumulator for emergency lowering of the arm system |
| • Suction valves for all work functions | • Cylinder end position damping | • Load-limit control |

SWING ASSEMBLY

| | | |
|--|---|--------------------------------|
| • Axial piston motor with priority valve | • Automatically controlled multi-disc brake | • Swing torque 41 kNm |
| • Planetary transmission | • Two, two-stage valves | • Max. swing speed 9/min |

TRACTION DRIVE AND BRAKES

| | | |
|---|--|--|
| • Variable displacement motor | • Automotive traveling and cruise control: | • Tractive force..... 87 kN |
| • Power-shift transmission | • Max. speed 20 km/h | • Gradeability 60 % |
| • Double-acting brake valve | • Off-road speed 5 km/h | • Dual-circuit brake system Multi-disc |
| • Travel direction pre-selection via switch in joystick | • Crawling speed..... 1 km/h | • Parking brake Multi-disc |

UNDERCARRIAGE

| | | |
|---|----------------------------|---------------------------------------|
| • Steering axle with automatic oscillating axle locking | • Heavy duty axles | • STD tires: Mitas 10.00-20 16PR EM23 |
| • Additional axis locking via left joystick | • Toolbox in undercarriage | |

TIRES

OPTIONAL:

| | | |
|--|---|---|
| • 4-road tyres 600/40 – 22.5 14PR Mitas | • 8-road tyres 10.00-20 16PR Nokia | • 8-road tyres 315/70 R22.5 Marked with a band, Grader type |
| • 4-road tyres 600/40 – 22.5 18PR Alliance | • 8-road tyres 10.00-20 16PR profile for asphalt use | • 8-road tyres 215/70 R22.5 Caliber Power Grip 23 |
| • 4-road tyres 710/40 – 22.5 24PR Nokia | • 8-road tyres 10.00-20 Super elastic (up to 16 km/h) | |

WORKING EQUIPMENT 165Wsr

DRIVER'S CAB

| | | |
|--|---|--|
| <ul style="list-style-type: none"> • Meets latest safety standards (ROPS) • Extra large entry zone • Spacious leg room • Radio preparation with mute function • Ready for electric cooling box • Different options for storage, compartment for documents • Heat-absorbing glass, tinted windows • Excellent all-way visibility • Bottle holder | DRIVER'S SEAT: <ul style="list-style-type: none"> • Comfort seat with headrest • Arm rests and lumbar support • Seat adjustable separately from console • Air suspension • Heated • Horizontal and vertical suspension • Lumbar support | MONITORING: <ul style="list-style-type: none"> • Operating data display screen • Automatic system for monitoring, warning and storage of data • Rear view security camera • Right side camera |
| | CONTROL: <ul style="list-style-type: none"> • Ergonomic joysticks with proportional slide control • Slim steering column, height and tilt adjustable • Indicators, controls and operating switches are clearly arranged • Swing axle lock in the left joystick | CLIMATE CONTROL: <ul style="list-style-type: none"> • Automatic climate control • Excellent air distribution through optimally arranged nozzles • Refrigerant R134a |
| | | SOUND LEVELS: <ul style="list-style-type: none"> • ISO 6396 (L_pA) in driver's cab 70 dB(A) • 2000/14 EG (L_wA) ambience level 97 dB(A) |

ADDITIONAL EQUIPMENT

| | | |
|--|--|--|
| <ul style="list-style-type: none"> • Refueling pump • Beacon light • Gear protection • Cabin Sliding door • Cab protection guard • Wheel cover • Cab elevation • Joystick steering • 270° camera system • LED working lights | <ul style="list-style-type: none"> • 35% axle differential lock • Patented trailer hitch • Alarm-signal while driving • Auxiliary heating with water circuit • Automatic working brake • Switch hydraulic attachment kit, supports separately at front and rear • Hydraulic add-on kit, switch supports axially separately • Proportional control of supports by slide in joystick • Automatically controlled and monitored electric central lubrication system for uppercarriage and arm equipment • Premium Driver seat (Actimo Evolution) | <ul style="list-style-type: none"> • Electric cooling box • Radio with USB • GPS/GSM telemetric system for monitoring of operating data, consumption, position • Biodegradable oil • Wide axles (overall width 2750 mm) • Wide dozer blade (2750 mm) • High-speed option 36 km/h • Additional counterweight 500 kg |
| | | Other additional equipment: See price list |
| | | Special options: upon request |

FILL CAPACITIES

| | | |
|--------------------------------|----------------------------------|-----------------------------------|
| • Fuel tank250 litres | • Engine oil.....10 litres | • Hydraulic system.....210 litres |
| • Cooling system.....35 litres | • Hydraulic tank175 litres | • Ad Blue®32 litres |

OPERATING WEIGHTS

| | MONOBLOCK BOOM 4.85 m (C6.4MG) | | ADJUSTABLE BOOM Base arm 1.87 m (C6.41) Boom 3.10 m (C6.46) | |
|----------------------|-----------------------------------|---------------------|---|---------------------|
| | Stick 2.15 m (D6.2) | Stick 2.65 m (D6.3) | Stick 2.15 m (D6.2) | Stick 2.65 m (D6.3) |
| Support dozer blade | 17.0 - 18.0 t | 17.1 - 18.1 t | 17.4 - 18.4 t | 17.5 - 18.5 t |
| SDB / outriggers | 17.8 - 18.8 t | 17.9 - 18.9 t | 18.2 - 19.2 t | 18.3 - 19.3 t |
| 4 support outriggers | 18.1 - 19.1 t | 18.2 - 19.2 t | 18.5 - 19.5 t | 18.6 - 19.6 t |

Operating weight incl. driver, fuel, lubricants and coolant plus 1.0 ton for attachments

ATTACHMENTS (SELECTION)

| | Bucket F415 | Bucket F418 | Trench digger G644 |
|---------------|---------------------|---------------------|---------------------|
| Capacity SAE | 0.67 m ³ | 0.92 m ³ | 0.56 m ³ |
| Cutting width | 850 mm | 1100 mm | 2000 mm |

WORK AREAS 165Wsr

Monoblock boom 4.85 m (C6.4MG)

Stick 2.15 m (D6.2)

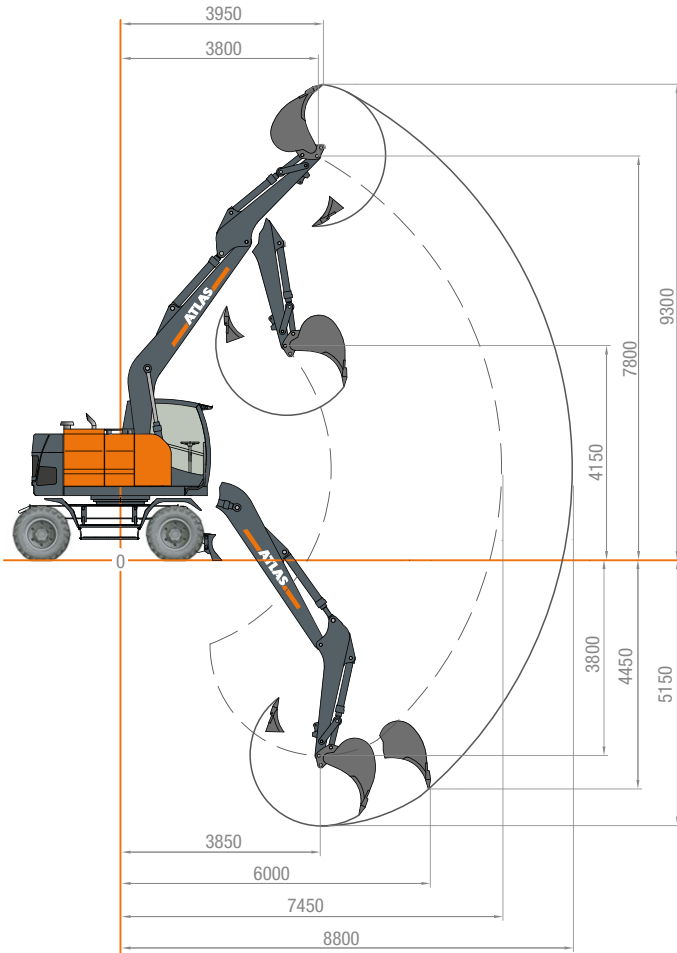

Stick 2.65 m (D6.3)

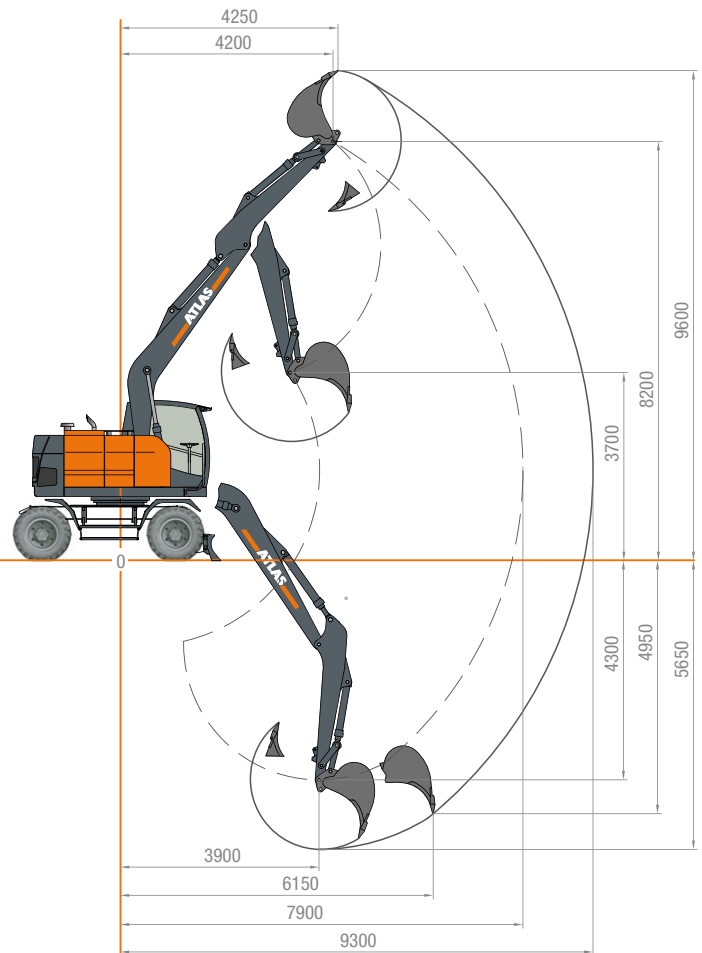





































| STICK LENGTHS | 2.15 m (D6.2) | 2.65 m (D6.3) |
|-------------------------------|---------------|---------------|
| A Max. cut-in height | 9.30 m | 9.60 m |
| B Max. pouring height | 6.30 m | 6.80 m |
| C Max. trench depth | 5.15 m | 5.65 m |
| D Max. vertical tapping depth | 8.80 m | 9.30 m |
| Max. bucket digging force | 144 kN | 144 kN |
| Max. stick digging force | 82 kN | 82 kN |

Unit is equipped with monoblock boom 4.85 m (C6.4MG).

LIFTING CAPACITIES 165Wsr

Lifting Capacities: Monoblock boom 4.85 m (C6.4MG) with Stick 2.15 m (D6.2). Max. Reach 8.80 m

with optional 4.5t weight

| Height | Undercarriage type | | 2.5 m | 3.0 m | 3.5 m | 4.0 m | 4.5 m | 5.0 m | 5.5 m | 6.0 m | 6.5 m | 7.0 m |
|----------|---|---------------------|-------|-------|-------|-------|-------|-------|-------|-------|-------|-------|
| + 5.0 m | FRONT  | SDB rear. supported | | | | | 4237 | 4002 | 3816 | 3673 | | |
| | LATERAL  | SDB front. raised | | | | | 4237 | 4002 | 3816 | 3673 | | |
| + 4.0 m | FRONT  | SDB supported | | | | | 4237 | *3847 | *3314 | *2883 | | |
| | LATERAL  | SDB raised | | | | | *3893 | *3308 | *2850 | *2476 | | |
| + 3.0 m | FRONT  | SDB rear. supported | 8326 | 6748 | 5781 | 5123 | 4645 | 4284 | 4002 | 3778 | 3600 | |
| | LATERAL  | SDB front. raised | 8326 | 6748 | 5781 | 5123 | 4645 | 4284 | 4002 | 3778 | 3600 | |
| + 2.0 m | FRONT  | SDB supported | 8326 | 6748 | 5781 | 5123 | *4359 | *3724 | *3229 | *2830 | *2498 | |
| | LATERAL  | SDB raised | 8326 | 6748 | *5403 | *4430 | *3725 | *3189 | *2767 | *2424 | *2137 | |
| + 1.0 m | FRONT  | SDB rear. supported | | | 6878 | 5851 | 5151 | 4641 | 4253 | 3947 | 3699 | 3492 |
| | LATERAL  | SDB front. raised | | | 6878 | 5851 | 5151 | 4641 | 4253 | 3947 | 3699 | 3492 |
| + 0 m | FRONT  | SDB supported | | | *5894 | *4881 | *4134 | *3563 | *3112 | *2746 | *2442 | *2182 |
| | LATERAL  | SDB raised | | | *4930 | *4120 | *3508 | *3033 | *2654 | *2343 | *2082 | *1857 |
| - 1.0 m | FRONT  | SDB rear. supported | | | 4581 | 6428 | 5579 | 4956 | 4481 | 4104 | 3796 | 3529 |
| | LATERAL  | SDB front. raised | | | 4581 | 6428 | 5579 | 4956 | 4481 | 4104 | 3796 | 3529 |
| - 2.0 m | FRONT  | SDB supported | | | 4581 | 6428 | 5579 | 4956 | 4481 | 4104 | 3796 | 3529 |
| | LATERAL  | SDB raised | | | *4524 | *3834 | *3300 | *2878 | *2537 | *2255 | *2019 | *1815 |
| - 3.0 m | FRONT  | SDB rear. supported | | | 4213 | 6609 | 5772 | 5119 | 4602 | 4182 | 3827 | 3508 |
| | LATERAL  | SDB front. raised | | | 4213 | 6609 | 5772 | 5119 | 4602 | 4182 | 3827 | 3508 |
| - 4.0 m | FRONT  | SDB supported | | | 4213 | *4399 | *3764 | *3278 | *2893 | *2580 | *2320 | *2102 |
| | LATERAL  | SDB raised | | | 4213 | *3658 | *3151 | *2757 | *2441 | *2181 | *1963 | *1779 |
| - 5.0 m | FRONT  | SDB rear. supported | | 3328 | 6213 | 6424 | 5687 | 5071 | 4558 | 4123 | 3736 | 3342 |
| | LATERAL  | SDB front. raised | | 3328 | 6213 | 6424 | 5687 | 5071 | 4558 | 4123 | 3736 | 3342 |
| - 6.0 m | FRONT  | SDB supported | | 3328 | *5265 | *4339 | *3692 | *3211 | *2836 | *2536 | *2291 | *2089 |
| | LATERAL  | SDB raised | | 3328 | *4333 | *3601 | *3082 | *2692 | *2386 | *2138 | *1934 | *1767 |
| - 7.0 m | FRONT  | SDB rear. supported | | 6606 | 6610 | 5944 | 5329 | 4782 | 4299 | 3857 | 3411 | |
| | LATERAL  | SDB front. raised | | 6606 | 6610 | 5944 | 5329 | 4782 | 4299 | 3857 | 3411 | |
| - 8.0 m | FRONT  | SDB supported | | 6606 | *5298 | *4347 | *3686 | *3200 | *2826 | *2531 | *2296 | |
| | LATERAL  | SDB raised | | *5527 | *4365 | *3608 | *3077 | *2682 | *2376 | *2133 | *1940 | |
| - 9.0 m | FRONT  | SDB rear. supported | 6508 | 6147 | 5666 | 5156 | 4659 | 4184 | 3718 | 3206 | 2733 | |
| | LATERAL  | SDB front. raised | 6508 | 6147 | 5666 | 5156 | 4659 | 4184 | 3718 | 3206 | 2733 | |
| - 10.0 m | FRONT  | SDB supported | 6508 | 6147 | *5375 | *4404 | *3729 | *3236 | *2862 | *2575 | | |
| | LATERAL  | SDB raised | 6508 | *5620 | *4438 | *3663 | *3118 | *2716 | *2410 | *2176 | | |
| - 11.0 m | FRONT  | SDB rear. supported | 4706 | 4556 | 4273 | 3919 | 3514 | 3038 | | | | |
| | LATERAL  | SDB front. raised | 4706 | 4556 | 4273 | 3919 | 3514 | 3038 | | | | |
| - 12.0 m | FRONT  | SDB supported | 4706 | 4556 | 4273 | 3919 | 3514 | 3038 | | | | |
| | LATERAL  | SDB raised | 4706 | 4556 | 4273 | 3919 | 3514 | 3038 | | | | |

Lifting Capacities: Monoblock boom 4.85 m (C6.4MG) with Stick 2.65 m (D6.3). Max. Reach 9.30 m

with optional 4.5t weight

| Height | Undercarriage type | | 2.5 m | 3.0 m | 3.5 m | 4.0 m | 4.5 m | 5.0 m | 5.5 m | 6.0 m | 6.5 m | 7.0 m | 7.5 m |
|----------|---|---------------------|-------|-------|-------|-------|-------|-------|-------|-------|-------|-------|-------|
| + 5.0 m | FRONT  | SDB rear. supported | | | | | | 3684 | 3534 | 3410 | 3313 | | |
| | LATERAL  | SDB front. raised | | | | | | 3684 | 3534 | 3410 | 3313 | | |
| + 4.0 m | FRONT  | SDB supported | | | | | | 3684 | *3374 | *2936 | *2573 | | |
| | LATERAL  | SDB raised | | | | | | *3379 | *2907 | *2526 | *2208 | | |
| + 3.0 m | FRONT  | SDB rear. supported | | | | 4663 | 4282 | 3985 | 3747 | 3553 | 3394 | 3264 | |
| | LATERAL  | SDB front. raised | | | | 4663 | 4282 | 3985 | 3747 | 3553 | 3394 | 3264 | |
| + 2.0 m | FRONT  | SDB supported | | | | 4663 | 4282 | *3791 | *3278 | *2868 | *2530 | *2244 | |
| | LATERAL  | SDB raised | | | | *4556 | *3812 | *3252 | *2813 | *2460 | *2167 | *1917 | |
| + 1.0 m | FRONT  | SDB rear. supported | 7562 | 6261 | 5414 | 4817 | 4372 | 4029 | 3755 | 3532 | 3345 | 3183 | |
| | LATERAL  | SDB front. raised | 7562 | 6261 | 5414 | 4817 | 4372 | 4029 | 3755 | 3532 | 3345 | 3183 | |
| + 0 m | FRONT  | SDB supported | 7562 | *6098 | *5004 | *4213 | *3616 | *3148 | *2771 | *2459 | *2197 | *1968 | |
| | LATERAL  | SDB raised | *6389 | *5121 | *4235 | *3582 | *3083 | *2687 | *2365 | *2098 | *1871 | *1672 | |
| - 1.0 m | FRONT  | SDB rear. supported | | 7226 | 6105 | 5321 | 4745 | 4305 | 3956 | 3672 | 3432 | 3217 | |
| | LATERAL  | SDB front. raised | | 7226 | 6105 | 5321 | 4745 | 4305 | 3956 | 3672 | 3432 | 3217 | |
| - 2.0 m | FRONT  | SDB supported | | *5606 | *4664 | *3968 | *3434 | *3010 | *2666 | *2380 | *2139 | *1930 | |
| | LATERAL  | SDB raised | | *4655 | *3910 | *3346 | *2906 | *2553 | *2263 | *2021 | *1814 | *1635 | |
| - 3.0 m | FRONT  | SDB rear. supported | 2704 | 6144 | 6484 | 5638 | 4996 | 4495 | 4094 | 3761 | 3475 | 3208 | |
| | LATERAL  | SDB front. raised | 2704 | 6144 | 6484 | 5638 | 4996 | 4495 | 4094 | 3761 | 3475 | 3208 | |
| - 4.0 m | FRONT  | SDB supported | 2704 | *5302 | *4418 | *3774 | *3281 | *2890 | *2572 | *2308 | *2085 | *1894 | |
| | LATERAL  | SDB raised | 2704 | *4366 | *3674 | *3159 | *2759 | *2437 | *2172 | *1950 | *1761 | *1599 | |
| - 5.0 m | FRONT  | SDB rear. supported | 4142 | 6810 | 6488 | 5688 | 5052 | 4537 | 4111 | 3749 | 3423 | 3190 | |
| | LATERAL  | SDB front. raised | 4142 | 6810 | 6488 | 5688 | 5052 | 4537 | 4111 | 3749 | 3423 | 3190 | |
| - 6.0 m | FRONT | SDB supported | 4142 | *5191 | *4292 | *3656 | *3180 | *2806 | *2504 | *2257 | *2050 | | |
| | LATERAL | SDB raised | 4142 | *4260 | *3553 | *3045 | *2660 | *2355 | *2106 | *1900 | | | |
| - 7.0 m | FRONT | SDB rear. supported | 6295 | 7016 | 6179 | 5478 | 4891 | 4395 | 3967 | 3579 | 3190 | | |
| | LATERAL | SDB front. raised | 6295 | 7016 | 6179 | 5478 | 4891 | 4395 | 3967 | 3579 | 3190 | | |
| - 8.0 m | FRONT | SDB supported | 6295 | *5186 | *4265 | *3621 | *3143 | *2774 | *2480 | *2242 | *2047 | | |
| | LATERAL | SDB raised | *5364 | *4256 | *3528 | *3012 | *2625 | *2324 | *2082 | *1885 | *1725 | | |
| - 9.0 m | FRONT | SDB rear. supported | 6983 | 6229 | 5562 | 4976 | 4461 | 3998 | 3563 | 3109 | | | |
| | LATERAL | SDB front. raised | 6983 | 6229 | 5562 | 4976 | 4461 | 3998 | 3563 | 3109 | | | |
| - 10.0 m | FRONT | SDB supported | *6702 | *5241 | *4298 | *3640 | *3157 | *2786 | *2496 | *2267 | | | |
| | LATERAL | SDB raised | *5445 | *4308 | *3559 | *3031 | *2638 | *2336 | *2098 | *1910 | | | |
| - 11.0 m | FRONT | SDB rear. supported | 6104 | 5571 | 5056 | 4565 | 4099 | 3647 | 3181 | | | | |
| | LATERAL | SDB front. raised | 6104 | 5571 | 5056 | 4565 | 4099 | 3647 | 3181 | | | | |
| - 12.0 m | FRONT | SDB supported | 6104 | 5571 | 5056 | *4385 | *3713 | *3222 | *2853 | | | | |
| | LATERAL | SDB raised | 6104 | 5571 | *4413 | *3643 | *3101 | *2702 | *2401 | | | | |

The specified max. loading capacities in kilogrammes (kg) include a stability of 25% or are calculated at 87% of the hydraulic lifting power, as per ISO10567. These values are applicable at the tip of the arm with optimum positioning of the corresponding arm system. Weights of attached load carrying accessories (grab, magnet, load hook, etc.) are not included with the load carrying values.

*Value limited due to excavator stability.

WORK AREAS 165Wsr

Adjustable Boom, Base arm 1.87 m (C6.41) and Boom 3.10 m (C6.46) with Stick 2.15 m (D6.2)

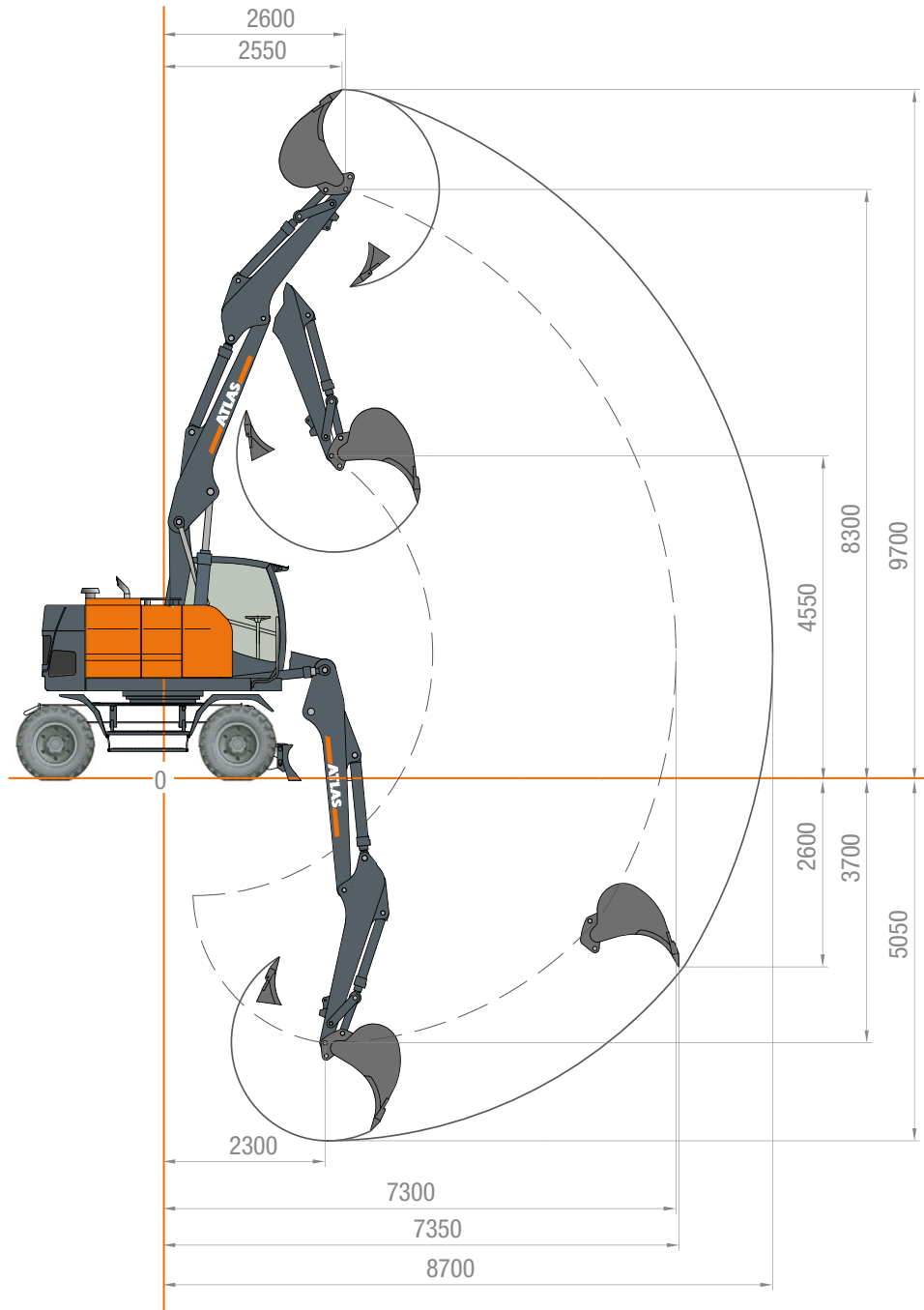

| STICK LENGTHS | 2.15 m (D6.2) |
|-------------------------------|---------------|
| A Max. cut-in height | 9,70 m |
| B Max. pouring height | 6,90 m |
| C Max. trench depth | 5,05 m |
| D Max. vertical tapping depth | 8,70 m |
| Max. bucket digging force | 144 kN |
| Max. stick digging force | 72 kN |

Unit is equipped with standard adjustable boom: base arm 1.87 m (C6.41) and boom 3.10 m (C6.46).

LIFTING CAPACITIES 165Wsr

Lifting Capacities: Adjustable Boom, Base arm 1.87 m (C6.41) and Boom 3.10 m (C6.46) with Stick 2.15 m (D6.2). Max. Reach 8.70 m with optional 4.5t weight

| Height | Undercarriage type | | 2.5 m | 3.0 m | 3.5 m | 4.0 m | 4.5 m | 5.0 m | 5.5 m | 6.0 m | 6.5 m | 7.0 m |
|----------|--------------------|---------------------|--------|-------|-------|-------|-------|-------|-------|-------|-------|-------|
| + 6.0 m | FRONT | SDB rear, supported | | | | 4494 | 4255 | 4069 | 3936 | | | |
| | LATERAL | SDB front, raised | | | | 4494 | 4255 | 4069 | 3936 | | | |
| + 5.0 m | FRONT | SDB supported | | | | 4494 | 4255 | *3906 | *3341 | | | |
| | LATERAL | SDB raised | | | | 4494 | *3996 | *3416 | *2874 | | | |
| + 4.0 m | FRONT | SDB rear, supported | | | 5204 | 4768 | 4429 | 4160 | 3945 | 3776 | | |
| | LATERAL | SDB front, raised | | | 5204 | 4768 | 4429 | 4160 | 3945 | 3776 | | |
| + 3.0 m | FRONT | SDB supported | | | 5204 | 4768 | 4429 | *3878 | 3384 | *2917 | | |
| | LATERAL | SDB raised | | | 5204 | *4677 | *3955 | *3405 | *2961 | *2507 | | |
| + 2.0 m | FRONT | SDB rear, supported | 7987 | 6997 | 5995 | 5304 | 4798 | 4411 | 4107 | 3861 | 3662 | |
| | LATERAL | SDB front, raised | 7987 | 6997 | 5995 | 5304 | 4798 | 4411 | 4107 | 3861 | 3662 | |
| + 1.0 m | FRONT | SDB supported | 7987 | 6997 | 5995 | *5217 | *4418 | 3819 | *3353 | *2947 | *2526 | |
| | LATERAL | SDB raised | 7987 | *6871 | *5498 | *4557 | *3876 | *3359 | *2951 | *2536 | *2163 | |
| + 0 m | FRONT | SDB rear, supported | 7859 | 7640 | 6991 | 5964 | 5253 | 4729 | 4326 | 4004 | 3739 | 3509 |
| | LATERAL | SDB front, raised | 7859 | 7640 | 6991 | 5964 | 5253 | 4729 | 4326 | 4004 | 3739 | *3369 |
| - 1.0 m | FRONT | SDB supported | 7859 | 7640 | *6115 | *5077 | *4327 | *3762 | *3318 | *2929 | *2519 | *2180 |
| | LATERAL | SDB raised | 7859 | *6603 | *5319 | *4441 | 3800 | *3309 | *2929 | *2519 | *2156 | *1854 |
| - 2.0 m | FRONT | SDB rear, supported | 8198 | 7838 | 7393 | 6466 | 5624 | 4999 | 4516 | 4129 | 3807 | 3519 |
| | LATERAL | SDB front, raised | 8198 | 7838 | 7393 | 6466 | 5624 | 4999 | 4516 | 4129 | 3807 | *3339 |
| - 3.0 m | FRONT | SDB supported | 8198 | *7516 | *6019 | 5001 | *4275 | *3727 | *3309 | *2871 | *2476 | *2152 |
| | LATERAL | SDB raised | 8198 | *6482 | *5228 | *4378 | *3757 | *3287 | *2900 | *2463 | *2113 | *1827 |
| - 4.0 m | FRONT | SDB rear, supported | 9448 | 8603 | 7643 | 6583 | 5755 | 5109 | 4592 | 4167 | 3815 | 3512 |
| | LATERAL | SDB front, raised | 9448 | 8603 | 7643 | 6583 | 5755 | 5109 | 4592 | 4167 | 3815 | *3292 |
| - 5.0 m | FRONT | SDB supported | 9448 | *7535 | *6005 | 4996 | 4275 | *3747 | *3251 | *2781 | *2408 | *2109 |
| | LATERAL | SDB raised | *8551 | 6485 | *5227 | *4374 | *3762 | *3237 | *2786 | *2374 | *2047 | *1784 |
| - 6.0 m | FRONT | SDB rear, supported | 11048 | 9310 | 7737 | 6607 | 5766 | 5116 | 4600 | 4186 | 3841 | 3244 |
| | LATERAL | SDB front, raised | 11048 | 9310 | 7737 | 6607 | 5766 | 5116 | 4600 | 4186 | 3841 | *3659 |
| - 7.0 m | FRONT | SDB supported | *10225 | *7627 | *6054 | *4993 | *4227 | *3642 | *3105 | *2677 | *2338 | *2077 |
| | LATERAL | SDB raised | *8336 | *6322 | *5078 | *4224 | *3595 | *3107 | *2644 | *2274 | *1978 | *1754 |
| - 8.0 m | FRONT | SDB rear, supported | 11891 | 9454 | 7837 | 6691 | 5841 | 5194 | 4702 | 4168 | 3421 | |
| | LATERAL | SDB front, raised | 11891 | 9454 | 7837 | 6691 | 5841 | 5194 | *4699 | *4088 | 3421 | |
| - 9.0 m | FRONT | SDB supported | *10078 | *7427 | *5872 | *4843 | *4106 | *3470 | *2976 | *2594 | *2299 | |
| | LATERAL | SDB raised | *8122 | *6123 | *4906 | *4080 | *3479 | *2940 | *2519 | *2192 | *1940 | |
| - 10.0 m | FRONT | SDB rear, supported | 12175 | 9707 | 8088 | 6914 | 5959 | 5104 | 4241 | 3104 | | |
| | LATERAL | SDB front, raised | 12175 | 9707 | 8088 | 6914 | 5959 | 5104 | 4241 | 3104 | | |
| - 11.0 m | FRONT | SDB supported | *10013 | *7352 | *5803 | *4716 | *3929 | *3349 | *2911 | *2573 | | |
| | LATERAL | SDB raised | *8063 | *6053 | *4840 | *3958 | *3308 | *2823 | *2456 | *2172 | | |

Lifting Capacities: Adjustable Boom, Base arm 1.87 m (C6.41) and Boom 3.10 m (C6.46) with Stick 2.15 m (D6.2). Max. Reach 8.70 m with optional 4.5t weight (wide axle in combination dozer blade 2.75m)

| Height | Undercarriage type | | 2.5 m | 3.0 m | 3.5 m | 4.0 m | 4.5 m | 5.0 m | 5.5 m | 6.0 m | 6.5 m | 7.0 m |
|----------|--------------------|---------------------|--------|-------|-------|-------|-------|-------|-------|-------|-------|-------|
| + 6.0 m | FRONT | SDB rear, supported | | | | 4494 | 4255 | 4069 | 3936 | | | |
| | LATERAL | SDB front, raised | | | | 4494 | 4255 | 4069 | 3936 | | | |
| + 5.0 m | FRONT | SDB supported | | | | 4494 | 4255 | 4069 | *3934 | | | |
| | LATERAL | SDB raised | | | | 4494 | 4255 | *4016 | *3452 | | | |
| + 4.0 m | FRONT | SDB rear, supported | | | 5204 | 4768 | 4429 | 4160 | 3945 | 3776 | | |
| | LATERAL | SDB front, raised | | | 5204 | 4768 | 4429 | 4160 | 3945 | 3776 | | |
| + 3.0 m | FRONT | SDB supported | | | 5204 | 4768 | 4429 | 4160 | *3918 | *3457 | | |
| | LATERAL | SDB raised | | | 5204 | 4768 | 4429 | 3984 | *3479 | *3019 | | |
| + 2.0 m | FRONT | SDB rear, supported | 7987 | 6997 | 5995 | 5304 | 4798 | 4411 | 4107 | 3861 | 3662 | |
| | LATERAL | SDB front, raised | 7987 | 6997 | 5995 | 5304 | 4798 | 4411 | 4107 | 3861 | 3662 | |
| + 1.0 m | FRONT | SDB supported | 7987 | 6997 | 5995 | 5304 | 4798 | 4411 | *3874 | *3439 | *3012 | |
| | LATERAL | SDB raised | 7987 | 6997 | 5995 | 5304 | *4534 | *3920 | *3448 | *3048 | *2621 | |
| + 0 m | FRONT | SDB rear, supported | 7859 | 7640 | 6991 | 5964 | 5253 | 4729 | 4326 | 4004 | 3739 | 3509 |
| | LATERAL | SDB front, raised | 7859 | 7640 | 6991 | 5964 | 5253 | 4729 | 4326 | 4004 | 3739 | 3509 |
| - 1.0 m | FRONT | SDB supported | 7859 | 7640 | 6991 | *5890 | *5003 | 4343 | *3825 | *3415 | *3005 | *2618 |
| | LATERAL | SDB raised | 7859 | 7640 | *6250 | *5205 | *4437 | *3861 | *3409 | *3031 | *2614 | *2268 |
| - 2.0 m | FRONT | SDB rear, supported | 8198 | 7838 | 7393 | 6466 | 5624 | 4999 | 4516 | 4129 | 3807 | 3519 |
| | LATERAL | SDB front, raised | 8198 | 7838 | 7393 | 6466 | 5624 | 4999 | 4516 | 4129 | 3807 | *3519 |
| - 3.0 m | FRONT | SDB supported | 8198 | 7838 | *6983 | *5789 | *4933 | *4295 | *3797 | *3415 | *2960 | *2590 |
| | LATERAL | SDB raised | 8198 | *7664 | *6147 | *5120 | *4382 | *3828 | *3396 | *2973 | *2570 | *2241 |
| - 4.0 m | FRONT | SDB rear, supported | 9448 | 8603 | 7643 | 6583 | 5755 | 5109 | 4592 | 4167 | 3815 | 3512 |
| | LATERAL | SDB front, raised | 9448 | 8603 | 7643 | 6583 | 5755 | 5109 | 4592 | 4167 | 3815 | *3503 |
| - 5.0 m | FRONT | SDB supported | 9448 | 8603 | *6971 | *5772 | *4922 | *4294 | 3819 | *3322 | *2891 | *2545 |
| | LATERAL | SDB raised | 9448 | *7677 | *6140 | *5117 | *4383 | 3840 | *3361 | *2883 | *2503 | *2197 |
| - 6.0 m | FRONT | SDB rear, supported | 11048 | 9310 | 7737 | 6607 | 5766 | 5116 | 4600 | 4186 | 3841 | 3244 |
| | LATERAL | SDB front, raised | 11048 | 9310 | 7737 | 6607 | 5766 | 5116 | 4600 | 4186 | 3841 | 3244 |
| - 7.0 m | FRONT | SDB supported | 11048 | 8887 | *7038 | 5827 | *4981 | *4349 | *3717 | *3217 | *2819 | *2513 |
| | LATERAL | SDB raised | *10371 | *7777 | *6213 | *5143 | *4362 | *3764 | *3217 | *2780 | *2433 | *2166 |
| - 8.0 m | FRONT | SDB rear, supported | 11891 | 9454 | 7837 | 6691 | 5841 | 5194 | 4702 | 4168 | 3421 | |
| | LATERAL | SDB front, raised | 11891 | 9454 | 7837 | 6691 | 5841 | 5194 | 4702 | 4168 | 3421 | |
| - 9.0 m | FRONT | SDB supported | 11891 | *9057 | *7137 | *5845 | *4934 | *4172 | *3585 | *3131 | *2780 | |
| | LATERAL | SDB raised | *10278 | *7617 | *6042 | *4994 | *4242 | *3593 | *3088 | *2699 | *2394 | |
| - 10.0 m | FRONT | SDB rear, supported | 12175 | 9707 | 8088 | 6914 | 5959 | 5104 | 4241 | 3104 | | |
| | LATERAL | SDB front, raised | 12175 | 9707 | 8088 | 6914 | 5959 | 5104 | 4241 | 3104 | | |
| - 11.0 m | FRONT | SDB supported | 12175 | *9050 | *7064 | *5713 | *4751 | *4048 | *3519 | 3104 | | |
| | LATERAL | SDB raised | *10215 | *7543 | *5973 | *4868 | *4066 | *3473 | *3024 | *2677 | | |

The specified max. loading capacities in kilogrammes (kg) include a stability of 25% or are calculated at 87% of the hydraulic lifting power, as per ISO10567. These values are applicable at the tip of the arm with optimum positioning of the corresponding arm system. Weights of attached load carrying accessories (grab, magnet, load hook, etc.) are not included with the load carrying values.

*Value limited due to excavator stability.

WORK AREAS 165Wsr

Adjustable Boom, Base arm 1.87 m (C6.41) and Boom 3.10 m (C6.46) with Stick 2.65 m (D6.3)

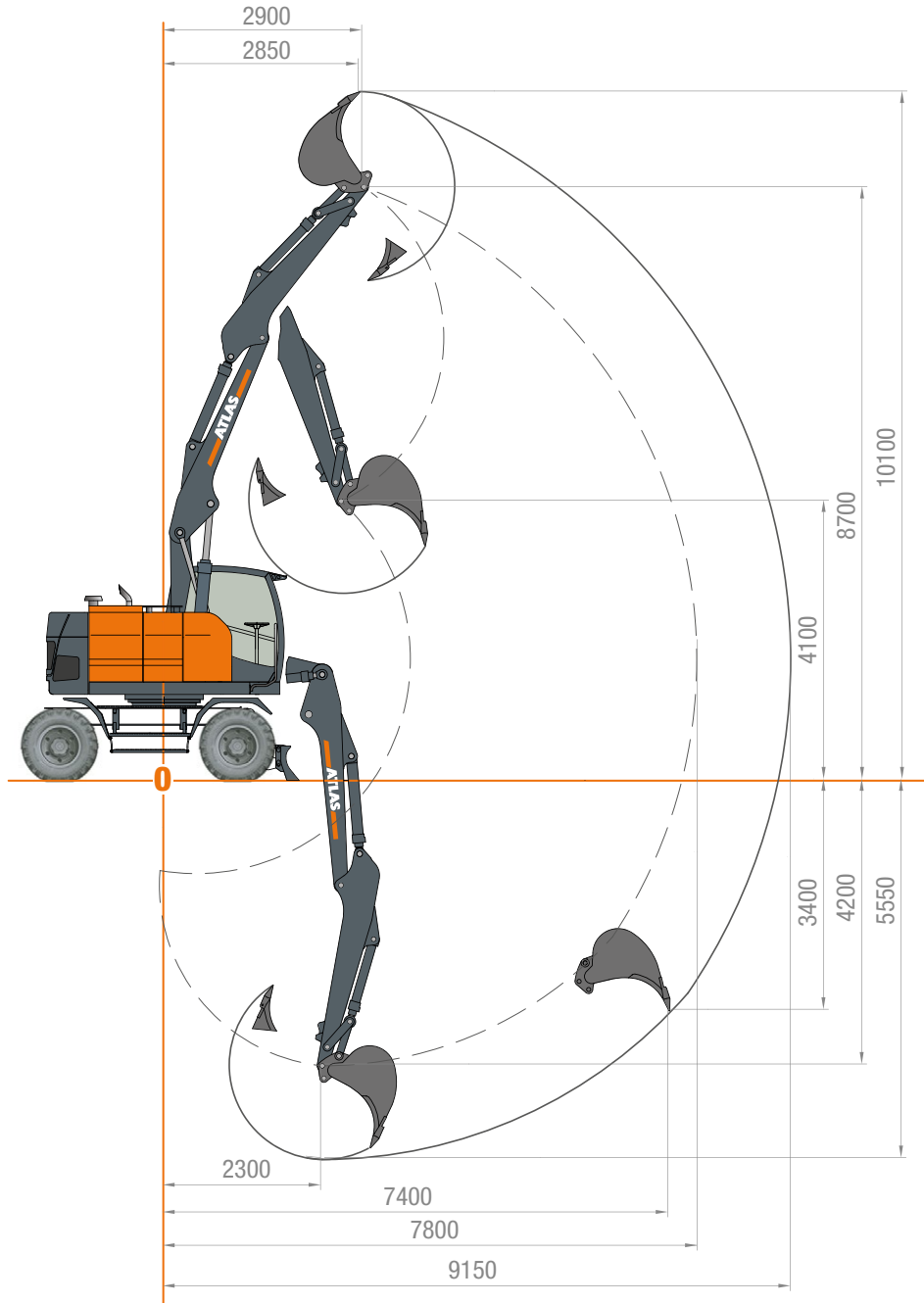

| STICK LENGTHS | 2.65 m (D6.3) |
|-------------------------------|---------------|
| A Max. cut-in height | 10.10 m |
| B Max. pouring height | 7.30 m |
| C Max. trench depth | 5.55 m |
| D Max. vertical tapping depth | 9.15 m |
| Max. bucket digging force | 144 kN |
| Max. stick digging force | 72 kN |

Unit is equipped with standard adjustable boom: base arm 1.87 m (C6.41) and boom 3.10 m (C6.46).

LIFTING CAPACITIES 165Wsr

Lifting Capacities: Adjustable Boom, Base arm 1.87 m (C6.41) and Boom 3.10 m (C6.46) with Stick 2.65 m (D6.3). Max. Reach 9.20 m with optional 4.5t weight

| Height | Undercarriage type | | 2.5 m | 3.0 m | 3.5 m | 4.0 m | 4.5 m | 5.0 m | 5.5 m | 6.0 m | 6.5 m | 7.0 m | 7.5 m |
|----------|--------------------|---------------------|--------|-------|-------|-------|-------|-------|-------|-------|-------|-------|-------|
| + 6.0 m | FRONT | SDB rear, supported | | | | | 3884 | 3733 | 3612 | 3522 | | | |
| | LATERAL | SDB front, raised | | | | | 3884 | 3733 | 3612 | 3522 | | | |
| + 5.0 m | FRONT | SDB supported | | | | | 3884 | 3733 | 3427 | *2965 | | | |
| | LATERAL | SDB raised | | | | | 3884 | *3465 | *3000 | *2553 | | | |
| + 4.0 m | FRONT | SDB rear, supported | | | | 4342 | 4077 | 3859 | 3679 | 3529 | 3407 | | |
| | LATERAL | SDB front, raised | | | | 4342 | 4077 | 3859 | *3406 | *3000 | *2603 | | |
| + 3.0 m | FRONT | SDB supported | | | | 4342 | *3992 | *3431 | 2993 | *2623 | *2237 | | |
| | LATERAL | SDB raised | | | | 4342 | *3992 | *3431 | 2993 | *2623 | *2237 | | |
| + 2.0 m | FRONT | SDB rear, supported | 5186 | 5521 | 5421 | 4874 | 4458 | 4132 | 3869 | 3653 | 3474 | 3322 | |
| | LATERAL | SDB front, raised | 5186 | 5521 | 5421 | 4874 | 4458 | 4132 | 3869 | 3653 | 3474 | 3322 | |
| + 1.0 m | FRONT | SDB supported | 5186 | 5521 | 5421 | 4874 | *4451 | *3832 | *3357 | *2974 | *2627 | *2266 | |
| | LATERAL | SDB raised | 5186 | 5521 | 5421 | *4594 | *3898 | *3365 | *2953 | *2617 | *2260 | *1937 | |
| + 0 m | FRONT | SDB rear, supported | 7987 | 7734 | 6428 | 5563 | 4946 | 4483 | 4121 | 3831 | 3590 | 3386 | 3201 |
| | LATERAL | SDB front, raised | 7987 | 7734 | 6428 | 5563 | 4946 | 4483 | 4121 | 3831 | 3590 | *3374 | *3039 |
| - 1.0 m | FRONT | SDB supported | 7987 | *7727 | *6158 | *5094 | *4334 | *3756 | *3302 | 2944 | *2610 | *2258 | *1962 |
| | LATERAL | SDB raised | 7987 | *6664 | 5350 | 4452 | *3800 | *3298 | *2908 | *2597 | *2244 | *1929 | *1664 |
| - 2.0 m | FRONT | SDB rear, supported | 8169 | 7911 | 7295 | 6182 | 5396 | 4812 | 4361 | 4001 | 3703 | 3448 | 3212 |
| | LATERAL | SDB front, raised | 8169 | 7911 | 7295 | 6182 | 5396 | 4812 | 4361 | 4001 | *3693 | *3354 | *3013 |
| - 3.0 m | FRONT | SDB supported | 8169 | *7494 | *5991 | *4977 | *4246 | 3698 | *3267 | *2930 | *2560 | *2218 | *1938 |
| | LATERAL | SDB raised | 8169 | *6457 | 5211 | *4351 | *3727 | *3254 | 2885 | *2566 | *2194 | *1890 | *1640 |
| - 4.0 m | FRONT | SDB rear, supported | 8952 | 8301 | 7523 | 6490 | 5654 | 5013 | 4509 | 4101 | 3759 | 3461 | 3203 |
| | LATERAL | SDB front, raised | 8952 | 8301 | 7523 | 6490 | 5654 | 5013 | 4509 | 4072 | *3676 | *3349 | *2969 |
| - 5.0 m | FRONT | SDB supported | 8952 | 7440 | 5941 | 4934 | *4219 | *3679 | *3269 | *2876 | *2479 | *2158 | *1897 |
| | LATERAL | SDB raised | *8432 | *6403 | *5161 | *4314 | *3701 | *3244 | *2859 | *2466 | *2115 | *1832 | *1600 |
| - 6.0 m | FRONT | SDB rear, supported | 10317 | 9015 | 7611 | 6506 | 5680 | 5039 | 4526 | 4108 | 3764 | 3484 | 2988 |
| | LATERAL | SDB front, raised | 10317 | 9015 | 7611 | 6506 | 5680 | 5039 | 4526 | 4075 | *3714 | *3278 | *2936 |
| - 7.0 m | FRONT | SDB supported | *10035 | 7492 | *5969 | *4965 | *4251 | *3676 | *3205 | *2748 | *2384 | *2092 | *1866 |
| | LATERAL | SDB raised | *8470 | *6418 | *5148 | *4275 | *3633 | *3138 | *2741 | *2341 | *2023 | *1767 | *1570 |
| - 8.0 m | FRONT | SDB rear, supported | 11530 | 9270 | 7686 | 6561 | 5723 | 5077 | 4568 | 4178 | 3784 | 3197 | |
| | LATERAL | SDB front, raised | 11530 | 9270 | 7686 | 6561 | 5723 | 5077 | 4568 | *4129 | *3623 | 3197 | |
| - 9.0 m | FRONT | SDB supported | *10102 | *7452 | *5892 | *4857 | *4116 | *3554 | *3036 | *2627 | *2300 | *2050 | |
| | LATERAL | SDB raised | *8140 | *6143 | *4922 | *4092 | *3486 | *3020 | *2576 | *2223 | *1941 | *1725 | |
| - 10.0 m | FRONT | SDB rear, supported | 11882 | 9455 | 7843 | 6703 | 5878 | 5234 | 4618 | 3960 | 3095 | | |
| | LATERAL | SDB front, raised | 11882 | 9455 | 7843 | 6703 | 5878 | 5234 | 4618 | 3960 | 3095 | | |
| - 11.0 m | FRONT | SDB supported | *9948 | *7309 | *5767 | *4753 | *3987 | *3376 | *2908 | *2549 | *2269 | | |
| | LATERAL | SDB raised | *7999 | *6009 | *4803 | *3991 | *3362 | *2848 | *2452 | *2147 | *1911 | | |

Lifting Capacities: Adjustable Boom, Base arm 1.87 m (C6.41) and Boom 3.10 m (C6.46) with Stick 2.65 m (D6.3). Max. Reach 9.20 m with optional 4.5t weight (wide axle in combination dozer blade 2.75m)

| Height | Undercarriage type | | 2.5 m | 3.0 m | 3.5 m | 4.0 m | 4.5 m | 5.0 m | 5.5 m | 6.0 m | 6.5 m | 7.0 m | 7.5 m |
|----------|--------------------|---------------------|--------|-------|-------|-------|-------|-------|-------|-------|-------|-------|-------|
| + 6.0 m | FRONT | SDB rear, supported | | | | | 3884 | 3733 | 3612 | 3522 | | | |
| | LATERAL | SDB front, raised | | | | | 3884 | 3733 | 3612 | 3522 | | | |
| + 5.0 m | FRONT | SDB supported | | | | | 3884 | 3733 | 3612 | *3486 | | | |
| | LATERAL | SDB raised | | | | | 3884 | 3733 | *3525 | *3066 | | | |
| + 4.0 m | FRONT | SDB rear, supported | | | | 4342 | 4077 | 3859 | 3679 | 3529 | 3407 | | |
| | LATERAL | SDB front, raised | | | | 4342 | 4077 | 3859 | 3679 | *3475 | 3090 | | |
| + 3.0 m | FRONT | SDB supported | | | | 4342 | 4077 | 3859 | 3679 | *3475 | 3090 | | |
| | LATERAL | SDB raised | | | | 4342 | 4077 | 3859 | *3500 | *3087 | *2697 | | |
| + 2.0 m | FRONT | SDB rear, supported | 5186 | 5521 | 5421 | 4874 | 4458 | 4132 | 3869 | 3653 | 3474 | 3322 | |
| | LATERAL | SDB front, raised | 5186 | 5521 | 5421 | 4874 | 4458 | 4132 | 3869 | *3437 | *3076 | *2706 | |
| + 1.0 m | FRONT | SDB supported | 5186 | 5521 | 5421 | 4874 | 4458 | 4132 | 3869 | *3437 | *3076 | *2706 | |
| | LATERAL | SDB raised | 5186 | 5521 | 5421 | 4874 | 4458 | *3938 | *3451 | *3010 | *2721 | *2354 | |
| + 0 m | FRONT | SDB rear, supported | 7987 | 7734 | 6428 | 5563 | 4946 | 4483 | 4121 | 3831 | 3590 | 3386 | 3201 |
| | LATERAL | SDB front, raised | 7987 | 7734 | 6428 | 5563 | 4946 | 4483 | 4121 | 3831 | 3590 | 3386 | 3201 |
| - 1.0 m | FRONT | SDB supported | 7987 | 7734 | 6428 | 5563 | 4946 | *4340 | *3817 | *3396 | 3055 | *2698 | *2362 |
| | LATERAL | SDB raised | 7987 | 7734 | *6287 | *5217 | *4440 | *3857 | 3395 | 3028 | *2704 | *2346 | *2044 |
| - 2.0 m | FRONT | SDB rear, supported | 8169 | 7911 | 7295 | 6182 | 5396 | 4812 | 4361 | 4001 | 3703 | 3448 | 3212 |
| | LATERAL | SDB front, raised | 8169 | 7911 | 7295 | 6182 | 5396 | 4812 | 4361 | 4001 | 3703 | 3448 | 3212 |
| - 3.0 m | FRONT | SDB supported | 8169 | 7911 | *6956 | 5767 | 4915 | *4267 | *3767 | *3366 | *3047 | *2657 | *2338 |
| | LATERAL | SDB raised | 8169 | *7639 | 6128 | 5097 | *4357 | *3797 | 3359 | *3010 | *2654 | *2306 | *2020 |
| - 4.0 m | FRONT | SDB rear, supported | 8952 | 8301 | 7523 | 6490 | 5654 | 5013 | 4509 | 4101 | 3759 | 3461 | 3203 |
| | LATERAL | SDB front, raised | 8952 | 8301 | 7523 | 6490 | 5654 | 5013 | 4509 | 4101 | 3759 | 3461 | *3162 |
| - 5.0 m | FRONT | SDB supported | 8952 | 8301 | 6897 | *5715 | *4868 | *4235 | *3751 | *3373 | *2964 | *2596 | *2296 |
| | LATERAL | SDB raised | 8952 | *7583 | 6069 | *5052 | *4326 | 3779 | *3356 | *2978 | *2573 | *2246 | *1979 |
| - 6.0 m | FRONT | SDB rear, supported | 10317 | 9015 | 7611 | 6506 | 5680 | 5039 | 4526 | 4108 | 3764 | 3484 | 2988 |
| | LATERAL | SDB front, raised | 10317 | 9015 | 7611 | 6506 | 5680 | 5039 | 4526 | 4108 | 3764 | 3484 | 2988 |
| - 7.0 m | FRONT | SDB supported | 10317 | *8729 | 6924 | *5729 | 4889 | *4264 | 3810 | *3290 | *2868 | *2529 | *2264 |
| | LATERAL | SDB raised | *10179 | *7634 | *6107 | *5084 | *4356 | *3797 | *3316 | *2850 | *2479 | *2181 | *1948 |
| - 8.0 m | FRONT | SDB rear, supported | 11530 | 9270 | 7686 | 6561 | 5723 | 5077 | 4568 | 4178 | 3784 | 3197 | |
| | LATERAL | SDB front, raised | 11530 | 9270 | 7686 | 6561 | 5723 | 5077 | 4568 | 4178 | 3784 | 3197 | |
| - 9.0 m | FRONT | SDB supported | 11530 | *8868 | 7039 | 5838 | *4945 | *4260 | *3648 | *3166 | *2783 | *2486 | |
| | LATERAL | SDB raised | *10301 | *7640 | *6061 | *5008 | *4251 | *3676 | *3148 | *2730 | *2396 | *2138 | |
| - 10.0 m | FRONT | SDB rear, supported | 11882 | 9455 | 7843 | 6703 | 5878 | 5234 | 4618 | 3960 | 3095 | | |
| | LATERAL | SDB front, raised | 11882 | 9455 | 7843 | 6703 | 5878 | 5234 | 4618 | 3960 | 3095 | | |
| - 11.0 m | FRONT | SDB supported | 11882 | *9007 | *7029 | *5753 | *4813 | *4076 | *3517 | *3086 | *2751 | | |
| | LATERAL | SDB raised | *10150 | *7500 | *5937 | *4904 | *4123 | *3499 | *3021 | *2652 | *2365 | | |

The specified max. loading capacities in kilogrammes (kg) include a stability of 25% or are calculated at 87% of the hydraulic lifting power, as per ISO10567. These values are applicable at the tip of the arm with optimum positioning of the corresponding arm system. Weights of attached load carrying accessories (grab, magnet, load hook, etc.) are not included with the load carrying values.
*Value limited due to excavator stability.

WORK AREAS 165Wsr

Adjustable Boom 1.87 m (C6.41), Base arm 3.35 m (C6.47) with Stick 2.65 m (D6.3)

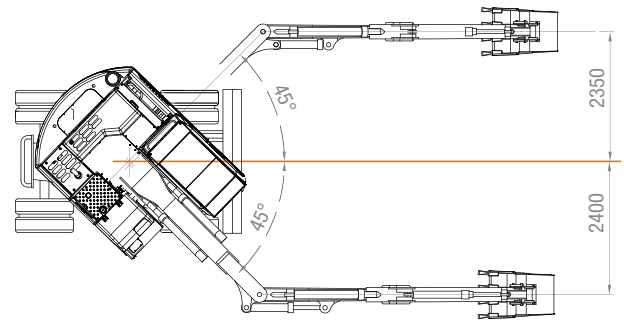
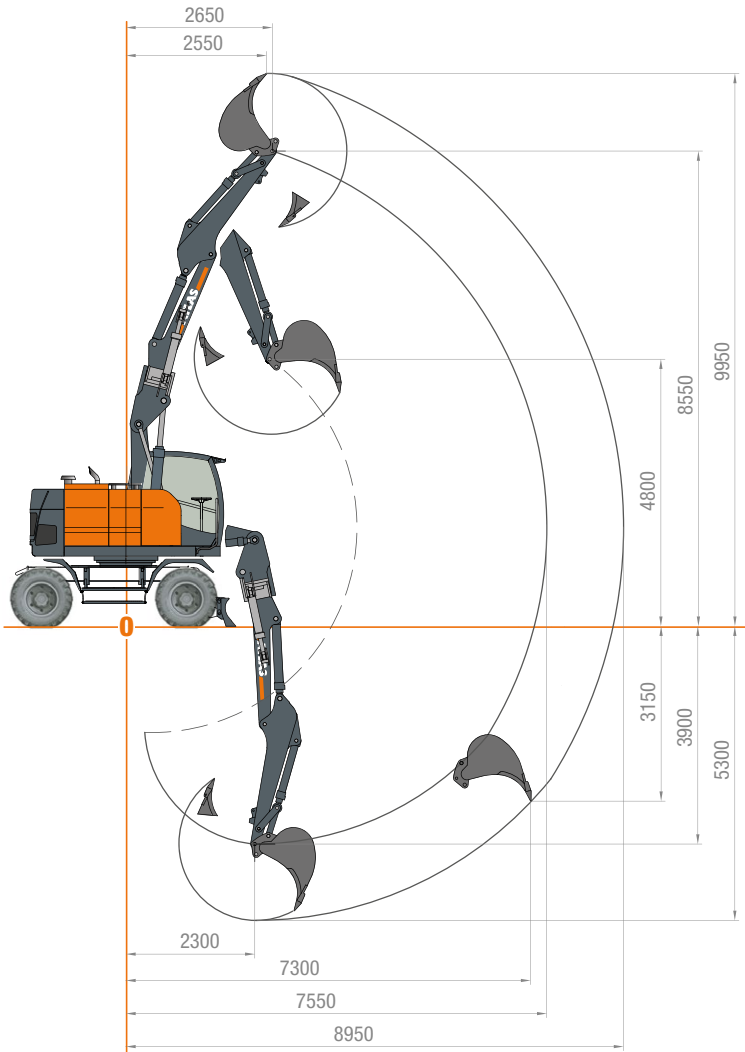



| STICK LENGTHS | | 2.65 m (D6.3) |
|---------------|-----------------------------|---------------|
| A | Max. cut-in height | 9.95 m |
| B | Max. pouring height | 7.15 m |
| C | Max. trench depth | 5.30 m |
| D | Max. vertical tapping depth | 8.95 m |
| | Max. bucket digging force | 144 kN |
| | Max. stick digging force | 72 kN |

Unit is equipped with standard adjustable boom: base arm 1.87 m (C6.41) and boom 3.35 m (C6.47).

LIFTING CAPACITIES 165Wsr

Lifting Capacities: Adjustable Boom, Base arm 1.87 m (C6.41) and boom 3.35 m (C6.47) with Stick 2.65 m (D6.3). Max. reach 8.95 m
with optional 4.5t weight

| Height | Undercarriage type | | 2.5 m | 3.0 m | 3.5 m | 4.0 m | 4.5 m | 5.0 m | 5.5 m | 6.0 m | 6.5 m | 7.0 m | 7.5 m |
|---------|---|---------------------|-------|-------|-------|-------|-------|-------|-------|-------|-------|-------|-------|
| + 5.0 m | FRONT  | SDB rear, supported | | | | 4283 | 3981 | 3736 | 3534 | 3366 | 3227 | 3116 | |
| | | SDB front, raised | | | | 4283 | 3981 | 3736 | 3534 | 3366 | 3227 | 3116 | |
| | LATERAL  | SDB supported | | | | 4283 | 3981 | 3736 | *3347 | *2943 | *2591 | *2206 | |
| | | SDB raised | | | | 4283 | *3939 | *3380 | *2939 | *2582 | *2219 | *1873 | |
| + 4.0 m | FRONT  | SDB rear, supported | 6712 | 6244 | 5401 | 4802 | 4352 | 4003 | 3724 | 3496 | 3306 | 3146 | 3009 |
| | | SDB front, raised | 6712 | 6244 | 5401 | 4802 | 4352 | 4003 | 3724 | 3496 | 3306 | 3146 | *2996 |
| | LATERAL  | SDB supported | 6712 | 6244 | 5401 | 4802 | 4352 | *3753 | *3281 | *2903 | 2593 | *2236 | *1913 |
| | | SDB raised | 6712 | 6244 | 5401 | *4514 | 3816 | 3299 | *2887 | 2555 | *2242 | *1903 | *1611 |
| + 3.0 m | FRONT  | SDB rear, supported | 6898 | 6900 | 6341 | 5441 | 4805 | 4329 | 3960 | 3665 | 3421 | 3215 | 3034 |
| | | SDB front, raised | 6898 | 6900 | 6341 | 5441 | 4805 | 4329 | 3960 | 3665 | 3421 | 3215 | *2979 |
| | LATERAL  | SDB supported | 6898 | 6900 | *5978 | *4954 | 4217 | *3652 | *3214 | *2862 | *2575 | *2223 | *1910 |
| | | SDB raised | 6898 | *6456 | *5199 | *4334 | *3696 | *3210 | *2831 | *2521 | *2224 | *1890 | *1609 |
| + 2.0 m | FRONT  | SDB rear, supported | 7381 | 7244 | 6910 | 5978 | 5200 | 4622 | 4176 | 3820 | 3527 | 3278 | 3056 |
| | | SDB front, raised | 7381 | 7244 | 6910 | 5978 | 5200 | 4622 | 4176 | 3820 | 3527 | *3238 | *2965 |
| | LATERAL  | SDB supported | 7381 | *7203 | *5788 | *4821 | *4112 | *3583 | *3166 | *2835 | *2538 | *2176 | *1877 |
| | | SDB raised | 7381 | *6230 | *5038 | *4212 | 3608 | *3150 | 2790 | *2508 | *2167 | *1844 | *1576 |
| + 1.0 m | FRONT  | SDB rear, supported | 8206 | 7726 | 7074 | 6198 | 5402 | 4787 | 4301 | 3907 | 3578 | 3294 | 3057 |
| | | SDB front, raised | 8206 | 7726 | 7074 | 6198 | 5402 | 4787 | 4301 | 3907 | 3539 | 3233 | *2908 |
| | LATERAL  | SDB supported | 8206 | 7160 | *5730 | *4763 | *4078 | *3558 | *3157 | *2862 | *2442 | *2104 | *1824 |
| | | SDB raised | 8122 | *6173 | 4985 | *4167 | 3580 | *3134 | 2798 | *2449 | *2073 | *1774 | *1524 |
| + 0 m | FRONT  | SDB rear, supported | 9626 | 8499 | 7264 | 6202 | 5411 | 4798 | 4309 | 3909 | 3580 | 3321 | 3006 |
| | | SDB front, raised | 9626 | 8499 | 7264 | 6202 | 5411 | 4798 | 4309 | *3905 | *3553 | *3217 | *2852 |
| | LATERAL  | SDB supported | 9626 | *7242 | *5772 | *4802 | *4109 | *3602 | *3141 | *2713 | *2327 | *2019 | *1772 |
| | | SDB raised | *8186 | *6225 | *5005 | *4163 | *3542 | *3060 | *2671 | *2301 | *1962 | *1690 | *1473 |
| - 1.0 m | FRONT  | SDB rear, supported | 10954 | 8889 | 7355 | 6269 | 5463 | 4843 | 4352 | 3965 | 3656 | 3228 | |
| | | SDB front, raised | 10954 | 8889 | 7355 | 6269 | 5463 | 4843 | 4352 | 3965 | *3551 | *3141 | |
| | LATERAL  | SDB supported | *9805 | *7242 | *5733 | *4731 | *4011 | *3464 | *2986 | *2556 | *2215 | *1948 | |
| | | SDB raised | *7848 | *5931 | *4759 | *3960 | *3376 | *2926 | *2521 | *2148 | *1852 | *1621 | |
| - 2.0 m | FRONT  | SDB rear, supported | 11452 | 9093 | 7528 | 6422 | 5609 | 5022 | 4496 | 3949 | 3286 | | |
| | | SDB front, raised | 11452 | 9093 | 7528 | 6422 | 5609 | 5022 | 4496 | 3949 | 3286 | | |
| | LATERAL  | SDB supported | *9651 | *7092 | *5597 | *4614 | *3915 | *3300 | *2816 | *2443 | *2152 | | |
| | | SDB raised | *7707 | *5791 | *4630 | *3848 | *3284 | *2767 | *2356 | *2038 | *1791 | | |
| - 3.0 m | FRONT  | SDB rear, supported | 11843 | 9472 | 7856 | 6601 | 5595 | 4700 | 3812 | 2744 | | | |
| | | SDB front, raised | 11843 | 9472 | 7856 | 6601 | 5595 | 4700 | 3812 | 2744 | | | |
| | LATERAL  | SDB supported | *9688 | *7102 | *5562 | *4484 | *3729 | *3170 | *2745 | *2421 | | | |
| | | SDB raised | *7741 | *5800 | *4596 | *3724 | *3105 | *2641 | *2287 | *2016 | | | |

The specified max. loading capacities in kilogrammes (kg) include a stability of 25% or are calculated at 87% of the hydraulic lifting power, as per ISO10567. These values are applicable at the tip of the arm with optimum positioning of the corresponding arm system. Weights of attached load carrying accessories (grab, magnet, load hook, etc.) are not included with the load carrying values.
*Value limited due to excavator stability.

DIMENSIONS 165Wsr

165Wsr Transport position

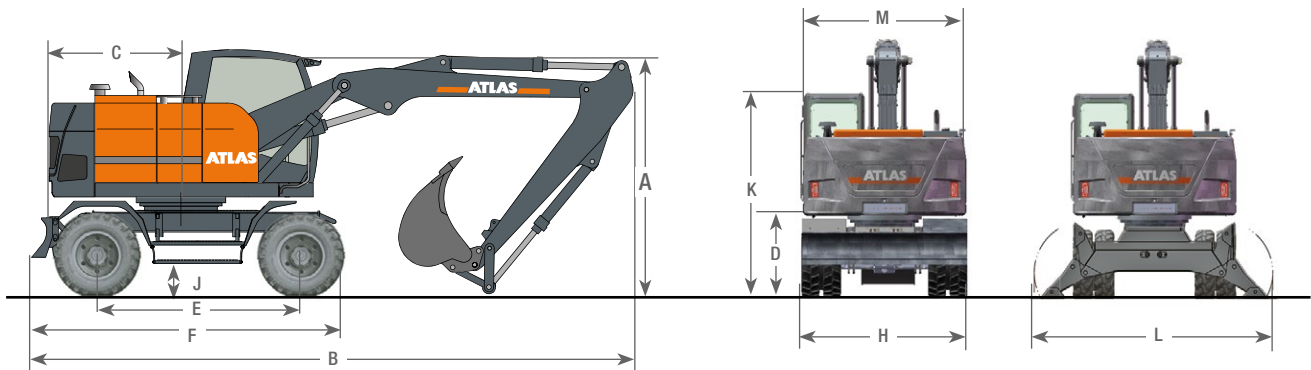

| | | | |
|----------|---|--------|---|
| A | TRANSPORT HEIGHT (with bucket) | | |
| | Adjustable boom* with Stick 2.15 m..... | 3.14 m | C TAIL SWING RADIUS.....1.69 m |
| | Adjustable boom* with Stick 2.65 m..... | 3.14 m | D CLEARANCE UNDER COUNTERWEIGHT1.26 m |
| | Monoblock boom 4.85 m with Stick 2.15 m | 3.14 m | E WHEEL BASE2.60 m |
| | Monoblock boom 4.85 m with Stick 2.65 m | 3.14 m | F UNDERCARRIAGE LENGTH4.00 m |
| B | TRANSPORT LENGTH | | H DOZER BLADE WIDTH2.54 m Optional.....2.74 m |
| | Adjustable boom* with Stick 2.15 m..... | 7.69 m | J GROUND CLEARANCE.....0.45 m |
| | Adjustable boom* with Stick 2.65 m..... | 8.20 m | K OVERALL HEIGHT OF CAB3.15 m |
| | Monoblock boom 4.85 m with Stick 2.15 m | 7.60 m | L OUTRIGGERS WIDTH (extended).....3.50 m |
| | Monoblock boom 4.85 m with Stick 2.65 m | 7,60 m | M OVERALL WIDTH OF SUPERSTRUCTURE.....2.50 m |

* Adjustable boom: Base arm 1.87 m (C6.41) and boom 3.10 m (C6.46)

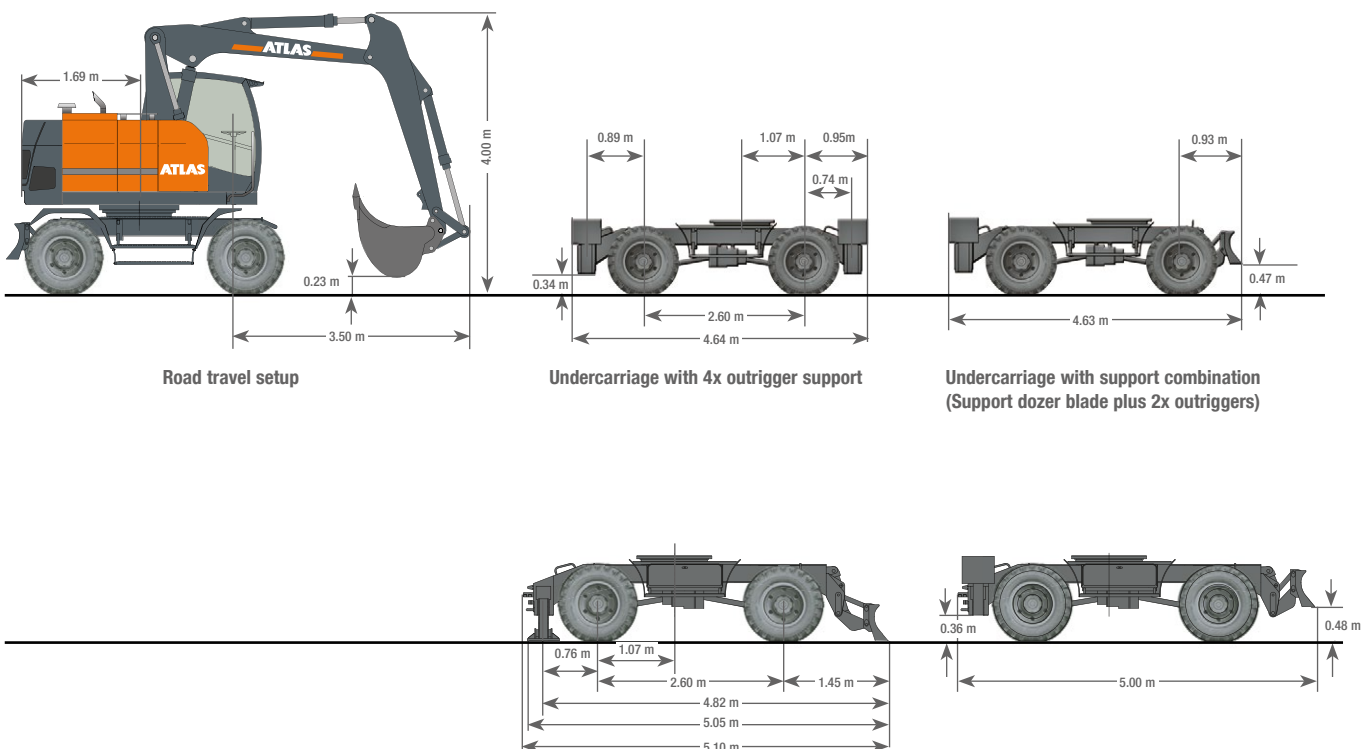



165Wsr-EN (1) Effective date: 07/2022. Product specifications and prices are subject to change without notice or obligation. The photographs and/or drawings in this document are for illustrative purposes only. Refer to the appropriate Operator's Manual for instructions on the proper use of this equipment. Failure to follow the appropriate Operator's Manual when using our equipment or to otherwise act irresponsibly may result in serious injury or death. The only warranty applicable to our equipment is the standard written warranty applicable to the particular product and sale and Atlas makes no other warranty, express or implied. The only warranty applicable to our equipment is the standard written warranty applicable to the particular product and sale and Atlas makes no other warranty, express or implied. Products and services listed may be trademarks, service marks or trade-names of Atlas GmbH and/or its subsidiaries. All rights are reserved. Atlas® is a registered trademark of Atlas GmbH. Copyright © 2022 Atlas GmbH. Ref. no.: 6203387

GANDERKESEE FACTORY

Atlas GmbH
Atlasstraße 6
D-27777 Ganderkesee,
Germany

Tel.: +49 (0) 4222 954 0
Fax: +49 (0) 4222 954 220
E-mail: info@atlasgmbh.com
www.atlasgmbh.com



VECHTA FACTORY

Atlas GmbH
Theodor-Heuss-Str. 3
D-49377 Vechta
Germany

T: +49 (0) 4441 954 0
F: +49 (0) 4441 954 299
E-mail: info@atlasgmbh.com
www.atlasgmbh.com



DELMENHORST FACTORY

Atlas GmbH
Stedinger Straße 324
D-27751 Delmenhorst
Germany

T: +49 (0) 4221 49 10
F: +49 (0) 4221 49 14 43
E-mail: info@atlasgmbh.com
www.atlasgmbh.com

ATLAS CRANES UK LTD NATIONAL SALES & SERVICE FACILITY

Wharfedale Road,
Euroway Trading Est.
Bradford, England BD4 6SL
United Kingdom

T: +44 8444 99 66 88
F: +44 1274 65 37 85
E-mail: atlasuk@atlasgmbh.com
www.atlas-cranes.co.uk
www.atlasgmbh.com

